

# Hot-rolled Wear Resistant Steel

## 热轧耐磨钢

[www.baosteel.com](http://www.baosteel.com)



## 前言 Preface

宝钢利用自身装备水平和技术力量，在国内率先研制成功高性能薄规格BW系列热轧耐磨钢，厚度范围为2-12mm，主要特征是采用热轧板作为基板进行热处理，规格薄，板形好，具有高耐磨、高韧性、抗冲击、易焊接、易成形等特点，产品性能和质量稳定。

本系列产品适用于重型卡车自卸车、垃圾收集车、混凝土搅拌车、工业风扇、料斗、碎料机、煤矿机械、粮食机械、抓斗等。

Baosteel wear resistant steel(BW) with 2 to 12mm in thickness was first developed in China by employing Baosteel's own equipments and long-term accumulated technology in production. BW steels are produced from processes of hot rolling, cutting into length and heat treating. The products are characterized with small thickness, good flatness, outstanding wear resistance, excellent toughness, good weldability, good machinability , consistent property and quality.

BW steels are developed for applications where high wear resistant performance is required, such as dumper, garbage vehicle, concrete mixer truck, industrial air fan, hopper, crusher, machinery for coal, grain, cement, grab bucket, etc.

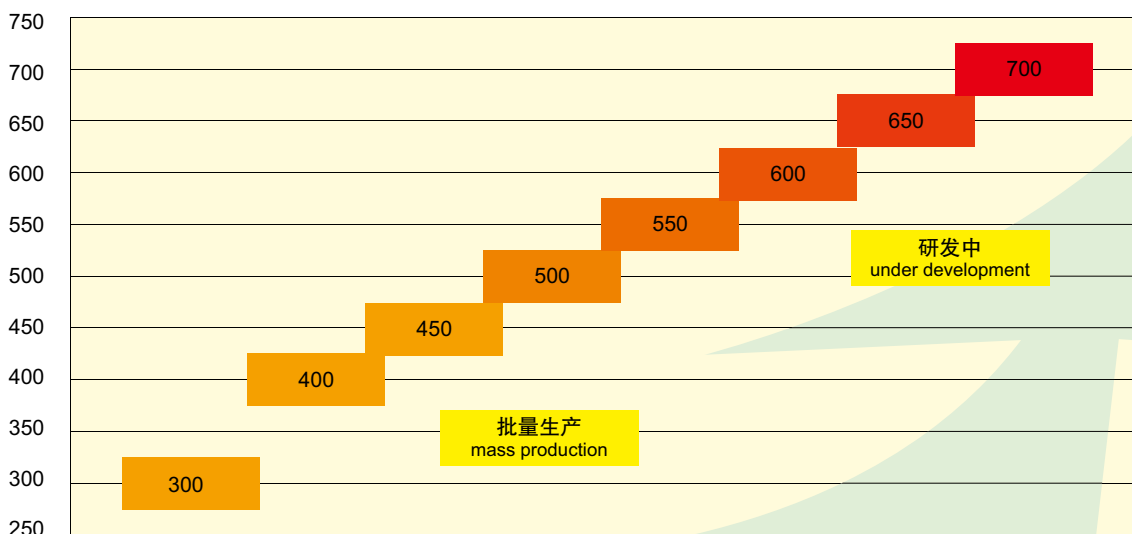

## 制造工艺及交货状态

### Manufacture process and delivery conditions

**生产工艺流程:** BW系列耐磨钢采用氧气转炉冶炼的镇静钢, 经过二次精炼后进行连续铸造, 连铸坯送热轧厂再加热并采用控轧控冷工艺轧制成卷, 经强力矫直切板后进行热处理, 性能质量检测合格后准发交货。

**交货状态:** BW系列热轧耐磨钢可采用控轧、淬火、淬火加回火等状态交货。

**加工配送服务:** 根据用户需求, 钢板可采用抛丸、涂漆表面预处理方式交货。可提供钢板下料、折弯、构件加工等延伸服务。常规规格备有现货, 交货周期短。

**Manufacture process:** The steel is made in oxygen converter, fully killed, secondary refined and cast into slabs. The slabs are reheated and rolled into coil in TMCP rolling process. After powerful leveling, cutting, heat treatment, and inspection, the BW series plates are delivered in sheets.

BW300TP may be delivered as rolled in coils or in sheets.

**Delivery condition:** TMCP, quenched, quenched and tempered etc.

**Processing and distribution service:** According to customers requirements, steel plate can be delivered with pretreatment such as blasting, painting etc. Additional services e.g., blanking, bending and machining are also provided. Delivery period for common size plates is very short benefit from our existing inventory.

牌号 Steel grade	厚度, mm Thickness	宽度, mm Width	长度, mm Length
BW450	3	1800	6000 8000
	4		
	5		
	6		
	8		
	10 12		

## 牌号及可供规格范围

### Steel grades and size

BW系列热轧耐磨钢可供规格如下表所示, 超出规格范围可与宝钢热轧耐磨钢产销研小组联系(附后)。

Specification of BW steels is tabulated in the following. If customer requirement is out of the specification range, please contact technical service for further assistance (attached).

牌号 Steel grade	可供厚度, mm Thickness	可供宽度, mm Width	可供长度, mm Length
BW300	2 - 12	850 - 1800	2000 - 12000
BW400	3 - 12	850 - 1800	2000 - 12000
BW450	3 - 12	950 - 1800	2000 - 12000
BW500	3 - 12	950 - 1800	2000 - 12000

## 产品性能

### Product properties

## 牌号含义

### Specification

#### BW450

**B:** Baosteel 宝钢 **W:** Wear resistant steel 耐磨钢 **450:** Brinell hardness value 布氏硬度级别

## 交货技术条件 – 力学性能

### Mechanical properties

牌号 Steel grade	厚度, mm Thickness	拉伸试验 Tensile test			布氏硬度 Brinell hardness	冲击试验 Impact test	90°弯曲试验 Bending
		屈服强度 ReH, MPa	抗拉强度 Rm, MPa	伸长率 Elongation A50mm,%	HBW	冲击值 Impact energy (-40℃)KV2,J	弯心直径 Bending diameter
BW300	2 – 12	≥850	≥1000	≥10	300±30	≥20	d = 5a
BW400	3 – 12	≥960	≥1200	≥8	400±30	≥20	d = 6a
BW450	3 – 12	≥1100	≥1300	≥7	450±30	≥20	d = 7a
BW500	3 – 12	-	-	-	500±30	≥20	d = 8a
BW300TP	3 – 6	≥600	≥900	≥8	200 – 400	-	-

注:

1. 拉伸试验采用横向试样，即试样长轴的方向垂直于轧制方向。
2. 冲击试验采用纵向V型缺口夏比试样，表列冲击值对应10×10×55mm标准试样，若采用5mm、7.5mm小试样，表中冲击值等比例减小；
3. 冷弯试验采用横向试样，d = 弯心直径，a = 钢板厚度。

Note:

1. Transversal specimen is adopted in tensile test, thus the long axis of specimen is vertical to rolling direction.
2. Longitudinal specimen is used in impact test, and the impact value is obtained from standard specimen(10×10×55mm); The impact value shall be reduced with equal proportion if the smaller sized specimen is used, such as 5mm, 7.5mm.
3. Transversal specimen is used in bending test. d=bending diameter, a=plate thickness

## 交货技术条件 – 化学成分，wt%

Chemical composition, wt%

牌号 Steel grade	C ≤	Si ≤	Mn ≤	P ≤	S ≤	Alt ≥	Cr ≤	Ni ≤	Ti ≤	B ≤	碳当量 典型值 CEV Typical values
BW300	0.23	0.70	1.60	0.020	0.008	0.015	0.80	0.50	0.05	0.005	0.42
BW400	0.30	0.70	1.60	0.020	0.010	0.015	1.00	0.70	0.05	0.005	0.46
BW450	0.35	0.70	1.60	0.020	0.010	0.015	1.10	0.80	0.05	0.005	0.52
BW500	0.38	0.70	1.60	0.020	0.010	0.015	1.20	0.80	0.05	0.005	0.55

碳当量CEV =  $C + Mn/6 + (Cr + Mo + V) / 5 + (Cu + Ni) / 15$

## 耐磨损性能

Wear resistance

### 1 销-盘法磨粒磨损实验

pin-on-disk wear test

耐磨性能采用销—盘法磨粒磨损实验检测。

实验条件：耐磨钢试样测试部分加工成  $\phi 4\text{mm}$  的圆柱，对磨材料选用粒度为120目的SiC砂纸，在84N载荷作用下进行实验。



图1 ML-100磨粒磨损试验机工作原理  
FIG. 1 schematic of pin-on-disk wear test rig

Wear resistance is evaluated with pin-on-disk abrasive wear test .

Experiment condition: Cylinder specimen of 4mm in diameter is prepared and tested with load force of 84N and grinding material of #120 SiC.

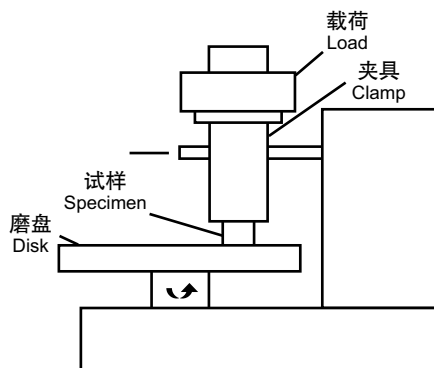

图2 测试后砂纸表面的螺旋线  
FIG. 2 spiral line on the coated abrasive disk after test

对宝钢BW400钢板沿厚度方向进行的耐磨性测试结果列于表1中，耐磨性实验结果与硬度测试结果一致，即在整个截面范围内耐磨性沿厚度方向变化较小；采用相同的试验条件检验了某进口品牌耐磨钢样板，试验结果列于表1，对比可见两者耐磨性相当。

The following table shows the wear loss of BW400 along the thickness direction. The result coordinates with hardness test. Wear resistance is generally consistent along the thickness direction. The contrast test is performed and results listed in the table below, BW400 and contrast steel have similar wear resistance.

BW400钢8mm厚钢板的耐磨性测试结果  
The wear test result of BW400 plate(8mm in thickness)

钢种 Steel grade	失重量 (毫克) Weight loss, mg				磨损率 loss ratio, mg/m			
	1	2	3	均值 average	1	2	3	均值 average
BW400	127.90	101.40	96.85	108.72	14.21	11.27	10.76	12.08
对比钢种 Contrast steel	128.55	133.35	122.10	128.00	14.28	14.82	13.57	14.22

## 2 环块磨损试验

### block-on-ring wear test

采用ASTM G77-05环块试验方法测试了BW400和Q345B钢板耐磨损性能，并加以对比，磨环副的材料为GCr15，硬度约为HRC60。磨损试验结果如表2所示，磨损面形貌如图3所示。采用环块试验方法测试结果表明，Q345B相对耐磨损约为BW400的30倍。

Wear resistance of BW400 and Q345B was evaluated with ASTM G77-05 block-on-ring wear test. The test ring material is GCr15 with hardness of 60 HRC. The result of test is shown in the table below, and the photo of block post-tested is shown in Fig.3. The block-on-ring wear test shows that wear loss of Q345B is about 30 times as much as that of BW400.

环块磨损试验结果  
Result of block-on-ring wear test

	平均磨痕宽度, mm Average scar width	磨损体积, mm <sup>3</sup> Volume loss	磨损率, mm <sup>3</sup> N <sup>-1</sup> m <sup>-1</sup> Volume loss rate
Q345B	6.90	10.0577	9.1571E-05
BW400	2.29	0.3638	3.3122E-06



图3 环块磨损试验后试样表面磨损形貌  
Fig.3 the block and scar surface after block-on-ring wear test

### 3 硬度试验

#### hardness

硬度是表征耐磨性能的关键指标之一，硬度越高，耐磨性能越好。BW450与Q345相比，硬度提高3倍，在同等工况条件下，平均使用寿命提高6-8倍。

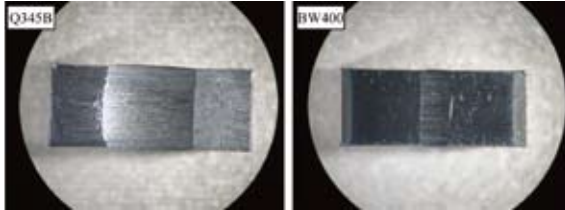
Hardness is a key to wear resistance performance. The higher hardness, the better wear resistance. Comparing with Q345, the hardness of BW450 is 3 times higher, the average service life is 6-8 times longer.

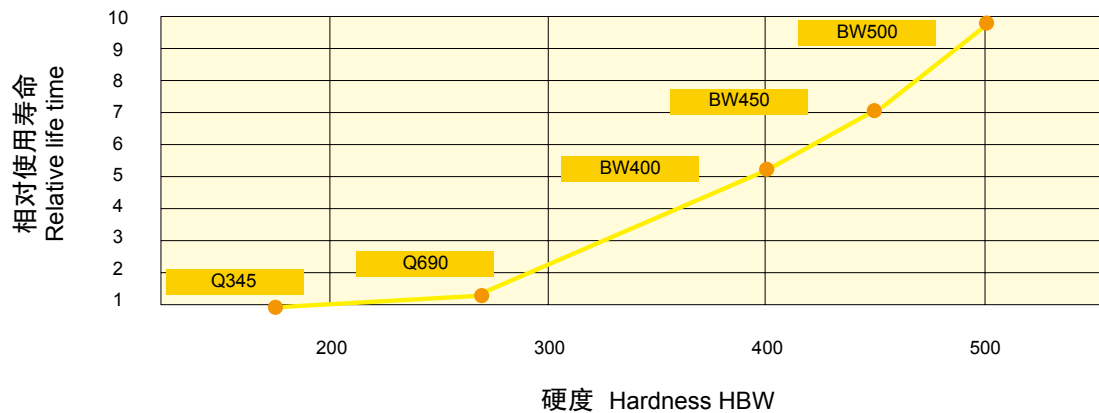

### 抗冲击凹陷性能

#### Dent resistance

BW耐磨钢板具有良好的冲击韧性,在承受重物冲击时,抗凹陷能力表现显著优于普通结构钢,该性能适用于制作自卸车车厢,适合钢板的减薄设计。

Due to its high strength, BW steels have better dimensional stability and can sustain a smaller amount of permanent deformation. Thinner plate can also be used than conventional steels. BW steels are suitable for the production of dumper bodies, for instance.

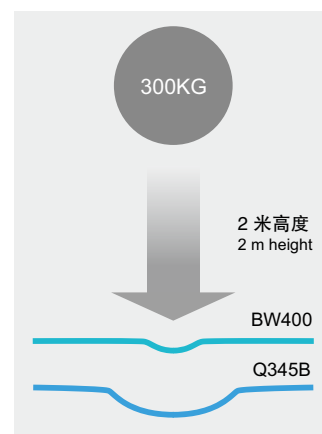

### 钢板尺寸、外形、重量及允许偏差

#### Dimension, shape, weight and tolerance

钢板尺寸、外形、重量及允许偏差满足《GB/T 709-2006热轧钢板和钢带的尺寸、外形、质量及允许偏差》的要求。

宝钢热轧耐磨钢采用特殊热处理方式，板形质量优异，整板不平度可以达到 $\leq 3\text{mm/m}$ 。

用户如对尺寸公差、不平度等有附加要求，供需双方协商确认，并在合同中注明。

Dimension, shape, weight and tolerance conform to *GB/T 709-2006 Dimension, shape, weight and tolerances for hot-rolled steel plates and sheets.*

BW steels are manufactured by special heat treatment process with superior flatness within 3mm/m.

Additional requirements on dimension tolerance, flatness etc. should be confirmed by supplier and customer and specified in contract.

### 产品使用技术

#### Customer services technologies

宝钢建设热轧耐磨钢一揽子使用技术团队，采用EVI（先期介入模式）为用户提供专业的热轧耐磨钢使用技术服务，从选材到设计、从下料加工到制造服役，全程为用户提供专业的技术指导。

Baosteel dedicates to giving a package solution of BW steels. With EVI(Eearly Vendor Involvement) model, our team will give professional, whole flow service, from material selecting, designing, processing to serve life.

### 设计与选材

#### Design and steel selection

宝钢拥有具备丰富专业知识和经验的EVI用户技术服务团队，专注于用户对产品使用过程的技术指导。配备全套的CAD和CAE分析软件，包括CATIA、UG、Hyperworks、AUTOFORM、DYNAFORM和ABAQUS等仿真分析平台。具备结构强度、刚度分析，设计优化和成型技术分析等能力，从用户使用角度提供更全面的技术支撑。

Baosteel has an experienced and professional EVI team to provide technical service for its customers. By using of CAD and CAE analysis software, such as CATIA, UG, Hyperworks, AUTOFORM, DYNAFORM and ABAQUS etc., the team is able to provide comprehensive technical support, including structural analysis, design optimization, machining and formability analysis.



类别 Parameter	单位 Unit	BW400	BW450
碳当量CEV ( IIW )	%	0.43	0.52
焊接裂纹敏感指数Pcm	%	0.25	0.29
屈服强度Re	MPa	1190	1200
抗拉强度Rm	MPa	1400	1430
断后伸长率 Elongation A50	%	12	12
夏比冲击功 ( -40℃ ) KV2,	J	80	60
表面布氏硬度HBW	HBW	400	450
90度冷弯, 弯心直径		D=6t	D=6t
弹性模量 Young's modulus ( 20℃ )	GPa	210	210
剪切模量 Shear modulus ( 20℃ )	GPa	80.8	80.8
泊松比 Poisson ratio ( 20℃~40℃ )	-	0.29	0.29
质量密度 Density	g/cm <sup>3</sup>	7.85	7.85
热导率 Thermal conductivity ( 25℃ )	W/(m.K)	48.54	48.54
热膨胀系数 Thermal expansivity ( 25℃ )	1/K	1.254×10 <sup>-5</sup>	1.254×10 <sup>-5</sup>
比热 Specific heat ( 25℃ )	J/(kg.K)	451.89	451.89

在设计阶段可能用到的一些热轧耐磨钢典型性能及参数如上表所示。

Typical values of parameters needed during design are listed above.

## 钻铣加工

### Drilling & milling

钻孔加工一般应采用高速钢或陶瓷硬质合金钢钻头。为保证批量钻孔作业时的高效和精确，我们推荐使用高速合金钢 ( HSS-E ) 或含钴高速合金钢 ( HSS-Co ) 钻头。

铣削加工时应确保夹紧工件，建议采用宽矩铣刀，平面铣刀的材质可选用硬质合金涂层、陶瓷合金等，端面铣刀可选用硬质合金、含钴高速合金钢等，尽量避免采用组合铣头，平面铣的切削宽度应为铣头直径的75% – 80%。

Either high speed steel or cemented carbide drills can be used for drilling. To ensure the efficiency and accuracy, micro-alloyed(HSS-E) or cobalt-alloyed(HSS-Co) drill is recommended.

Work piece should be clamped tightly while milling and wide-space milling cutter is recommended. Carbide coating, ceramic alloy etc. can be used as the material of flat cutter, and hard alloy, cobalt-alloyed high speed steel etc. as end cutter, trying to avoid combined milling head. Cutting width of flat milling is 75-80% of the diameter of milling head.

## 折弯加工

### Bending

钢板可进行折弯加工，但必须严格控制折弯内径和角度。钢板进行冷弯时钢板的强度越高，需要的弯曲力越大，回弹力和回弹角度越大，因而应采用合适的上模直径和下模开口度。表4推荐了BW系列耐磨钢的折弯加工工艺。

BW steels are suitable for bending if the bending diameter and angle are strictly controlled. The bending force and the springback of BW steels are greater than that of common steel. Suitable punch radius and die open width are listed as below

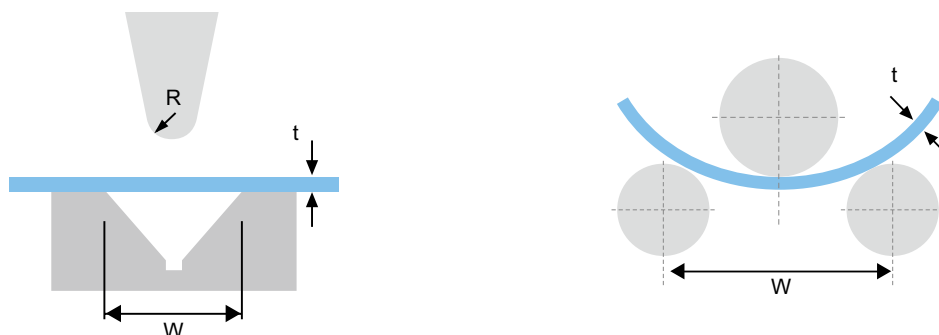

90度折弯加工时推荐工艺参数及可能的回弹角

Possible springback angel after 90° bending and recommended parameters

牌号 Steel grade	板厚, mm Thickness	最小折弯内径 Minimum bending radius R		下模开口最小距离 Minimum die open width W		回弹角 Springback angle °
		纵向 Longitude	横向 Transvers	纵向 Longitude	横向 Transvers	
BW350	t<8	4t	6t	7t	9t	7 - 11
	8≤t<12	5t	6t	8t	9t	
BW400	t<8	5t	6t	9t	10t	9 - 13
	8≤t<12	6t	8t	10t	10t	
BW450	t<8	7t	8t	10t	10t	11 - 18
	8≤t<12	8t	10t	10t	12t	

为避免钢板边部因加工硬化造成弯曲开裂，可适当采用打磨机去除毛边。

钢板纵向冷弯性能略好于横向冷弯性能，因而进行相同弯曲角度的折弯时时，横向弯曲内径应略大一些。所谓纵向是指钢板的轧制方向垂直于折弯机冲头长度方向。

In order to avoid the crack caused by work hardening during cutting, the cut edge of BW steels may be smoothed before bending.

It is easier to bend the BW steels from longitudinal direction than transverse direction. The bending diameter is greater for transverse bending than longitudinal bending. Here transverse bending means the rolling direction of the plates is vertical to the punch.

表5 BW450常用折弯工艺参数速查  
Table 5 bending parameters of BW450

板厚t, mm Thickness	6	8	10
折弯内径D, mm Bending diameter	≥36	≥64	≥80
下模开口距离W, mm Die open width	≥60	≥80	≥100
若冲压力计算条件为 Bending conditions	W=75, Rm=1350	W=90, Rm=1350	W=110, Rm=1350
则每米折弯冲压力P, t Bending force per meter	104	154	196

折弯力可参照如下公式计算：

Bending force can be calculated as follows:

$$P = \frac{1,6 \times b \times t^2 \times R_m}{10000 \times W}$$

其中：

P = 折弯冲压力 ( bending force, t ) , b = 宽度 ( width, mm ) ,

t = 厚度 ( thickness, mm ) , Rm = 抗拉强度 ( Rm, MPa ) ,

W = 下模开口距离 ( Die open width, mm ) 。

## 热切割

### Thermal Cutting

宝钢热轧耐磨钢钢板适用于热切割包括氧气燃料火焰切割、等离子切割、激光切割等。

钢板热切割时可能会产生切边裂纹，和焊接裂纹相似是一种延迟裂纹。钢板的硬度和厚度越大，出现切边裂纹的风险也越高。热轧耐磨钢由于板厚较薄，在低温环境下热切割时适当降低切割速度是防止切边裂纹的有效方法，另外切割之前适当预热，切割后对工件保温缓冷，在一定程度上也可以降低切割边缘的残余应力。

钢板热切割或热加工时，钢板会因为受热而产生软化，钢板的抗软化能力取决于钢的化学成分、显微组织及加工方式，切割工件越小，热量会在工件中聚集导致软化的风险越大。避免软化风险的最好方式是采用冷切割和冷加工。如果必须进行热切割时，优先使用激光切割或等离子切割。水下等离子切割可以大大缩小热影响区、防止工件硬度降低、减少切割部件变形、降低噪音、无烟尘。

BW steels are suitable for thermal cutting such as flame cutting, laser cutting and plasma cutting.

Thermal cutting may result in cutting crack which is a delayed crack, similar to welding crack. The higher of hardness and thickness, the more risk of crack occurring. As work in low temperature conditions, reducing the cutting speed is the effective way to avoid cutting crack. Another way is preheating before gas cutting. Heat preservation after cutting can reduce residual stress of heat-affected zone.

Softening may occur during thermal cutting or thermal treating. The softening resistance of steel depends on the chemical composition, micro structure and treating process. The smaller of workpiece, the more risk of softening because of heat accumulation. The best way to prevent softening is using cold cutting and cold working. If thermal cutting has to be used, laser cutting or plasma cutting in water is recommended.

#### 典型切割工艺参数

#### Typical cutting parameters

切割方式 Cutting method	切割速度 Cutting speed mm/min	切口宽度 Cutting gap mm	热影响区宽度 Width of heat-affected zone mm	尺寸公差 Size tolerance mm
水刀切割 Water jet cutting	8-150	±0.2	0	±0.2
激光切割 Laser cutting	600-2200	±0.2	0.4 - 3	±0.2
等离子切割 Plasma cutting	1200-6000	±1.0	2 - 5	±1.0
火焰切割 Flame cutting	150-700	±2.0	4 - 10	±2.0

注：  
以上数据均为参考值，具体视生产情况而定。

Note:  
Data shown above is for reference.

## 剪切

### Shear cutting

高强耐磨钢可以进行剪切，但抗拉强度越大，所需的剪切力就越大，我们不建议对BW400、BW450及以上耐磨钢钢板进行剪切。

剪切时，应选择坚硬、锋利、并稍带一点圆边的刀刃。剪切过程中刀刃间隙也应随钢板强度的不同而变化，强度越大，刀刃间隙越大，不合理的刀刃间隙会影响切面质量。在实际操作中，具体还要依据生产设备的情况而定。

It is possible but not recommended to cut the BW steels by shear cutting for the high cutting force.

If shear cutting has to be used, rigid and sharp blade with a little chamfer is recommended. The gap of blades should be adjusted with plate strength. The higher the strength, the bigger the gap.

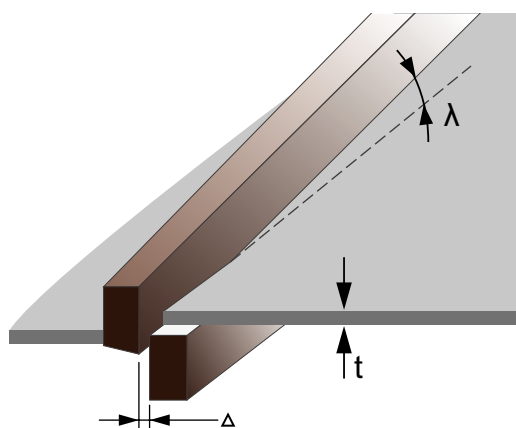

t : 钢板厚度  
Plate thickness

λ : 剪刀倾斜角  
Blades inclination angle

Δ : 剪刀间隙  
Blades gap

剪切工艺基本参数 (仅作参考)  
Basic parameters of shear cutting (for reference)

牌号 Steel grade	剪刀间隙 $\Delta = 16\% - 18\%$ 板厚 blades gap $\Delta = 16\% - 18\%$ plate thickness	剪刀倾斜角 Blades inclination angle $\lambda$
BW450	板厚 = 6mm, $\Delta = 0.96 - 1.08$ 板厚 = 8mm, $\Delta = 1.28 - 1.44$ 板厚 = 10mm, $\Delta = 1.6 - 1.8$	$3^\circ - 5^\circ$

## 焊接

### Welding

宝钢热轧耐磨钢由于采用低碳当量设计，属于可焊接钢种，推荐焊接工艺要点如下：

- 1 建议采用实心焊丝进行MAG 焊接，焊接保护气体为(15-25%)CO<sub>2</sub>的富Ar气体，气体流量为18~25 l/min。
- 2 优先选用低氢焊接材料，手工焊条焊接时，优先选用碱性焊条。
- 3 根据焊缝设计位置及受力状态，可选用80kg级高强度焊丝，或选用普通50kg级焊丝。
- 4 环境温度为0℃以上时，焊前无需预热，也无需焊后热处理。
- 5 焊接时尽量不摆动，采用多层多道焊接，焊接热输入量建议不超过10KJ/cm，注意焊缝外形应美观。
- 6 可采用对接、角接、搭接等焊接接头形式，采用搭接接头时，搭接量应不小于较薄钢板板厚的5倍，最小搭接量不小于25mm。

BW steels have good weldability since the low carbon equivalent. The main points of welding are shown as following.

- 1 MAG welding with solid wire is recommended. The shielding gas is Ar with (15-25%) CO<sub>2</sub>, the gas flow is 18-25 l/min.
- 2 Ultra low hydrogen welding rod is recommended. Alkaline rod is preferred during manual welding.
- 3 The strength of weld material can be 800MPa or 500MPa, depending on the position and enduring of welding joint.
- 4 When ambient temperature is above 0℃, BW steels can be welded directly without preheating and post-treatment.
- 5 In order to guarantee the performance of welding joint, multi-layer and non-swing welding is recommended. The maximum heat input Q= 10 KJ/cm.
- 6 The common types include butt joint, angle joint, and overlap joint. When overlap joint is adopted, the overlap should not less than 5 times of plate thickness, and not less than 25mm.

## 应用案例

### Application case

国内某专用车厂原采用钢板Q345制造某型号宽体重型自卸车车厢，底板厚度20mm，侧围板厚度16mm，采用BW400耐磨钢设计后，底板厚度减薄至10mm，侧围板厚度为8mm，宝钢耐磨钢产销研发团队对样车进行了仿真计算和优化，跟踪了加工过程和服役使用，进行了耐磨损性能实测，焊缝全部完好，样车表现良好，达到用户设计目标。

样车在矿上投入使用约3个月时，对底板厚度进行了测量对比，采用BW400耐磨钢制作的底板减薄0.3mm，而同期投入使用的Q345B减薄3mm，这表明，耐磨钢使用寿命约为普通结构钢的10倍。

Usually the body of heavy dumper body is made with Q345B. The thickness is 20mm in the bottom plate and 16 mm in the side plate. After application of BW450, the thickness of bottom plate reduced to 10mm, and that of side plate reduced to 8mm. The new vehicle was designed and simulated with Baosteel's service team. Evaluating report of the new dumper body shows that the weld joint has outstanding strength and wear-resistance, as well as the whole body. The whole vehicle meets custom's requirements.

After 3 month service of the dumper in a mine field, the lost thickness for the BW450 bottom plate is only 0.3mm while 3mm for Q345. It shows the lifetime of BW450 is 10 times of Q345B.

## 结语

### Our vision

宝钢一贯秉持“要善于学习，更要善于创新”的创业精神，在热轧耐磨钢的开发征程上勇于开拓进取，产品不断升级换代，技术不断突破创新，我们愿以更好的产品和服务全心全意效力于国内外制造业的进步发展。

Following the creed, "Good at learning and better at innovation", Baosteel is pioneering in BW steel development, product upgrading, and technology breakthrough. With better products and better service, Baosteel will contribute its best to the development of both the domestic and overseas manufacture industry.

#### 宝钢热轧耐磨钢用户服务主要联系人

【产品技术】**温东辉** 研究院热轧所 021-26647336 wendh@baosteel.com

【焊接技术】**屈朝霞** 研究院焊接所 021-26649519 quzx@baosteel.com

【客户服务】**纪海岩** 客户与产品服务部机电室 021-26645554

【销售管理】**李东杰** 薄板销售部热轧室 021-26641197

#### Technical Customer Service

【Product technology】**Donghui Wen**, Research institute, 021-26647336

【Welding technology】**Zhaoxia Qu**, Research institute, 021-26649519

【Customer service】**Haiyan Ji**, Customer and product service department, 021-26645554

【Sales management】**Dongjie Li**, Steel sheet sales department, 021-26641197



采用宝钢热轧耐磨钢BW400制造的矿用重型自卸车  
Tipper body of heavy dump truck using hot rolled BW400 of Baosteel



采用宝钢热轧耐磨钢BW450制造的矿用重型自卸车  
Tipper body of heavy dump truck using hot rolled BW450 of Baosteel

**宝山钢铁股份有限公司**  
http://www.baosteel.com

**BAOSHAN IRON & STEEL CO., LTD.**  
http://www.baosteel.com

**薄板销售部**  
**Steel Sheet Sales Department**  
地址: 上海宝山同济路1800号  
邮编: 201900  
电话: 021-26641669  
传真: 021-26645005

**客户与产品服务部**  
**Customer and Product Service Department**  
地址: 上海宝山同济路1800号  
邮编: 201900  
电话: 021-26648888  
传真: 021-26645295

**宝钢服务热线**  
**Baosteel Service Hot-line**  
400-820-8590

**宝钢在线**  
http://www.baosteel.net.cn

#### 国内贸易公司 Domestic Sales Channels

**上海宝钢钢材贸易有限公司**  
电话: 021-50509696  
传真: 021-68404618

**广州宝钢南方贸易有限公司**  
电话: 020-32219999  
传真: 020-32219555

**北京宝钢北方贸易有限公司**  
电话: 010-56512000  
传真: 010-56512199

**成都宝钢西部贸易有限公司**  
电话: 028-85335388  
传真: 028-85335680

**武汉宝钢华中贸易有限公司**  
电话: 027-84298800  
传真: 027-84298224

**沈阳宝钢东北贸易有限公司**  
电话: 024-31391158  
传真: 024-31391160

**上海宝钢商贸有限公司**  
电话: 021-60869800  
传真: 021-60869804

**上海宝钢浦东国际贸易有限公司**  
电话: 021-36014655  
传真: 021-51266522 51266533

**上海宝钢宝山钢材贸易有限公司**  
电话: 021-36014688  
传真: 021-51266500

#### 东北亚及澳洲大区 Northeast Asia and Oceania Region

**宝和通商株式会社**  
**HOWA TRADING CO., LTD.**  
TEL: 0081-3-3237-9121  
FAX: 0081-3-3237-9123

**宝和通商首尔事务所**  
**HOWA TRADING CO., LTD., SEOUL OFFICE**  
TEL: 0082-2-5080893  
FAX: 0082-2-5080891

**宝钢澳大利亚贸易有限公司**  
**BAO AUSTRALIA PTY LTD.**  
TEL: 0061-8-94810535  
FAX: 0061-8-94810536

#### 东南亚及南亚大区 South East Asia and South Asia Region

**宝钢新加坡贸易有限公司**  
**BAOSTEEL SINGAPORE PTE LTD.**  
TEL: 0065-63336818  
FAX: 0065-63336819

**宝钢印度公司**  
**BAOSTEEL INDIA COMPANY PRIVATE LTD.**  
TEL: 91-22-30071700  
FAX: 91-22-30071777

**越南代表处**  
**VIETNAM OFFICE**  
TEL: 0084-8-39100126  
FAX: 0084-8-39100124

**泰国代表处**  
**THAILAND OFFICE**  
TEL: 0066-2-6543008  
FAX: 0066-2-6543010

#### 欧非中东大区 Europe, Africa & Middle East Region

**宝钢欧洲有限公司**  
**BAOSTEEL EUROPE GMBH**  
TEL: 0049-40-41994101  
FAX: 0049-40-41994120

**宝钢中东代表处**  
**BAOSTEEL MIDDLE EAST REPRESENTATIVE OFFICE**  
TEL: 00971-4-8840458  
FAX: 00971-4-8840485

**宝钢西班牙有限公司**  
**BAOSTEEL ESPAÑA, S.L.**  
TEL: 0034-93-4119325  
FAX: 0034-93-4119330

**宝钢意大利钢材集散中心有限公司**  
**BAOSTEEL ITALIA DISTRIBUTION CENTER SPA**  
TEL: 0039-010-5308872  
FAX: 0039-010-5308895

**宝钢东欧代表处**  
**BAOSTEEL CENTRAL AND EAST EUROPE OFFICE**  
TEL: 0048-32-7315012  
FAX: 0048-32-7315011

#### 美洲大区 America Region

**宝钢美洲贸易有限公司**  
**BAOSTEEL AMERICA INC.**  
TEL: 001-201-3073355  
FAX: 001-201-3073358

**底特律代表处**  
**DETROIT OFFICE**  
TEL: 001-248-2089918  
FAX: 001-248-2080999

**休斯顿代表处**  
**HOUSTON OFFICE**  
TEL: 001-281-4847333  
FAX: 001-281-4842655

**洛杉矶代表处**  
**LOS ANGELES OFFICE**  
TEL: 001-949-7526789  
FAX: 001-949-7521234

**宝钢巴西贸易有限公司 (宝美巴西代表处)**  
**BAOSTEEL DO BRAZIL PTE LTDA.**  
TEL: 0055-21-25311363  
FAX: 0055-21-25310298

